

Dear users, functional setting of this device requires some expertise. Therefore, please carefully read and fully understand the instruction before use.

Operating Instruction for AL3000-HD 8-CH Hybrid HD MDVR



Thank you for choosing our product. Difference between models or product upgrading may result in appearance or features different from those described in the instruction; thus, it all depends on the actual product or you can contact the manufacturer.







Information contained herein is subject to irregular change without prior notice.

Statement







This instruction is applicable for AL3000-HD 8-ch hybrid HD series MDVR products. Information contained herein may not be technically accurate. If any conflict between the product and the instruction is found during usage, it all depends on the actual product or you can contact the manufacturer. Information contained herein is subject to irregular change without prior notice.

Usage Precautions



1. Installation Environment

-  To extend the service life, please try to install the device in a place where vibration is weak;
-  To ensure normal heat dissipation, do not install the device in a poorly-ventilated area (such as trunk), and also keep about 15 cm away from other objects on the same level;
-  The device shall be horizontally installed and protected against water, humidity and lightning; in addition, keep the vehicle still during installation to prevent damage to the device due to falling off;
-  To ensure safe operation, keep the device, camera, cables and other accessories out of reach of passengers and driver.

2. Avoid Electric Shock and Fire

-  **8V-36V** DC power supply is used for this device. Please note the positive and negative terminals during connection to prevent short circuit;
-  Please power the device off before connecting any peripheral ;
-  Do not touch the power supply and the device with wet hands;
-  Do not spray liquid on the device to prevent internal short circuit or fire;
-  Do not place any other device directly on top of the camera;
-  Do not disassemble the housing without authorization to avoid damage or electric shock;

3. Transport and Handling

-  To prevent incidental damage to the device during transport. Handle the device with due care. The original packaging materials and carton are preferred;
-  Power the device off before handling or part replacement to prevent any damage;

一、 Product Description.....	5
1. Product Overview.....	5
2. Introduction to Mainframe.....	6
3. Introduction to Main Keys of Your Remote Control.....	8
1. Installation.....	10
1.1: Open the protective cover.....	10
1.2: Prepare the HDD.....	10
1.3: Insert the HDD.....	11
1.4: Install SIM and SD cards.....	11
1.5: Lock the electric lock.....	12
1.6: Install the mainframe.....	13
1.7: Install GPS, 3G/4G, WiFi antenna.....	13
1.8: Connect the power cord.....	13
1.9: Connect the display output unit.....	14
1.10: Alarm input and output cable.....	15
1.11: RS232/RS485 device connection.....	16
1.12: Connect PTZ.....	17
2. Connection Method of This Solution.....	18
三. Basic Settings.....	19
1. Basic Setup:.....	20
1.1: Basic Setup.....	20
1.2: set Date & Time.....	20
1.3: Set Vehicle INFO.....	21
1.4: User Setup.....	22
1.5: Network Setup.....	23
1.6: Display Setup.....	24
1.7: CODE OSD.....	24
2. Channel Mode.....	25
3. Record Setup:.....	26
3.1: Enter the Record Setup interface.....	26
3.2: Record Basic Setup.....	26
3.3: Main Code.....	27
3.4: Sub-Stream Setup.....	28
3.5: Recording Schedule (to be set in timing record mode).....	28
3.6: Mirror Record(Customize).....	29
3.7: SD Record.....	29
3.8: IPC.....	30
4. Alarm Setup:.....	32
4.1: Enter the Alarm Setup interface.....	32
4.2: Sensor Setup.....	32
4.3: Speed Setup.....	33
4.4: G-sensor Setup.....	34
4.5: Temperature Setup.....	34
4.6: ALARM OUT Setup.....	35
4.7: Motion Detection.....	35
4.8: Other Alarm.....	37
5. Configuration:.....	37

5.1:Enter system tools.....	37
5. 2: Configuration management.....	38
5. 3: Formatting.....	38
5. 4: Log Search.....	39
6.Peripheral Setup:.....	39
6.1: Enter the Peripheral Setup interface.....	39
6.2: PTZ.....	40
6.3: Wireless Setup.....	40
6. 4: WiFi Setup.....	41
6.5: Fuel Setup.....	42
6. 6: Serial Device Setup.....	42
7. Record Search:.....	43
8. System Information:.....	43
Appendix 1: Common Questions and Answers (QA) for MDVR.....	44
Appendix 2: AL3000-HD Memory Space Reference.....	48

一、 Product Description

1. Product Overview

AL3000-HD is a vehicle HD MDVR, which supports 8 channels analog audio and video recording and playback at the same time. It supports network function, RJ45 is used to connect with external LAN or 1 1080P IP camera. The device supports up to 8 analog cameras + 1 1080P IPC recorder at the same time. The product adopts ARM DSP fast dual-core processor running on the Linux embedded OS, and also integrates the most advanced H.264 video encoding/decoding in IT industry, 3G/4G network, GPS and WiFi, as well as fail-safe protection, HDD shock absorption, HDD heating, wide voltage features. It is extensively applied in public buses, logistics vehicles, school buses, coaches, tour buses, police cars, financial convoy cars and fuel tankers etc.

Features:

- H.264 image compression encoding supported, AL3000-HD:200fps@720P PAL
- AL3000-HD supports 8 channels analog audio and video recording and playback at the same time. The device supports up to 8 analog cameras + 1 1080P IPC recording at the same time.
- Air video interface is used to provide high reliability and strong anti-seismic property
- Built-in 3G/4G network, GPS, WiFi (optional)
- Built-in 2.5" HDD, max. 2TB HDD supported, damping technique
- Good scalability, 1 RS485 interface, 2 RS232 interfaces
- 8V-36V wide voltage DC supply, 12V POE power supply supported
- HDD heating technique supported, operating temperature range -40°C + 80°C

2. Introduction to Mainframe



NOTE:the product standard version haven't USB2.0 interface,it can be customize if you need.

AL3000 - HD air head is 6 pins

AL3000-HD Interface Diagram:

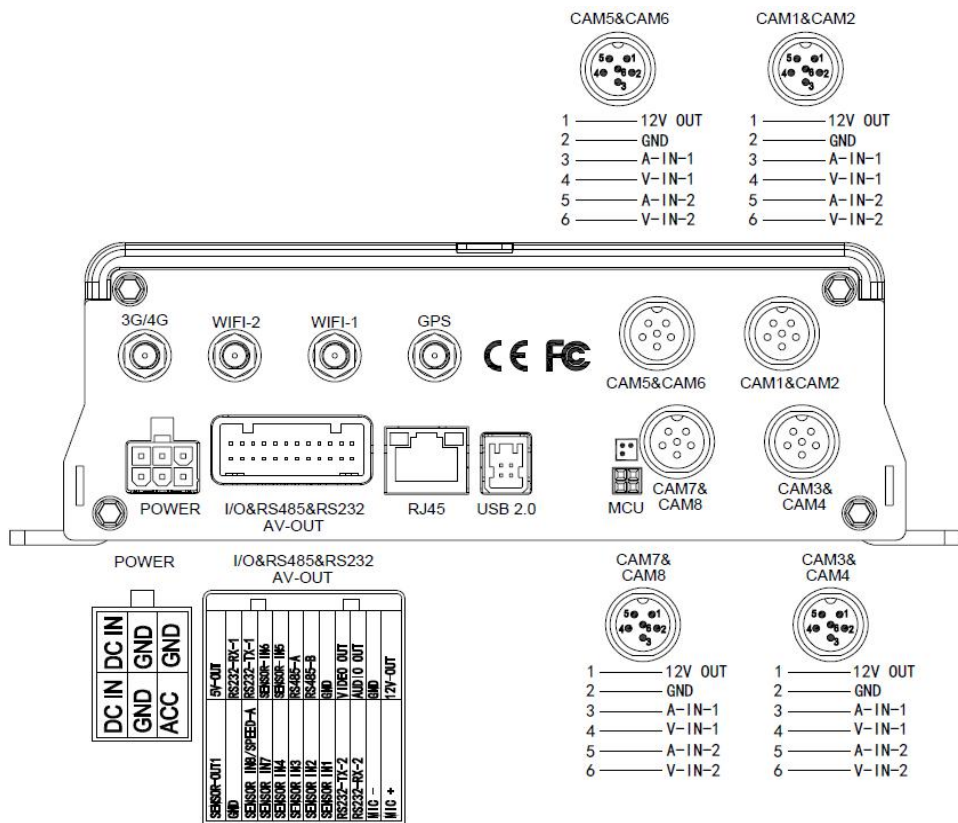

3.Introduction to Main Keys of Your Remote Control

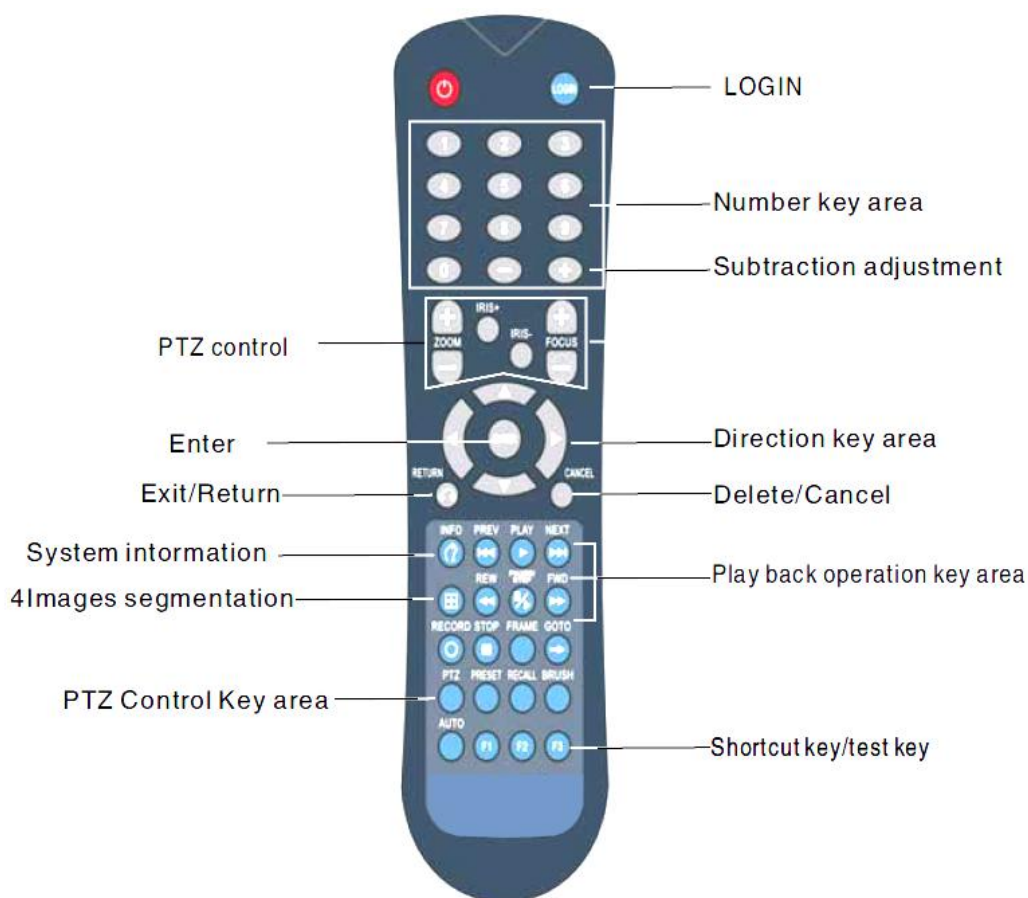

LOGIN	When the recorder is set with a password, press the Login key to input your password. As the system is not provided with recover and reset features, always keep your password in mind.
INFO key	Check information
Quad View key Number key 1, 2, 3, 4	On the monitoring interface, used to switch between quad view and single view; press the Quad View key to display 4 screens. You can press number 1/2/3/4 to display channel 1, channel 2, channel 3 and channel respectively.
RETURN	Return to the previous menu, and finally exit from the setup menu to the monitoring interface
PAUSE/STEP key	Used to pause playing or play images at a single step. Press the key again to recover normal play speed

FRAME	Press this key to play a video in a frame rate
PLAY	Press this key to start playing (search the video file to be played and select, then press the key to play it)
FWD	Forward key in four grades: 2X,4X,8X,16X
REW	Rewind key in four grades: 2X,4X,8X,16X
NEXT key	Page down or roll to the next file
PREV key	Page up or roll to the previous file
PTZ key	PRESET、RECALL、BRUSH Auto, preset, call, zoom +, zoom -, focus +, focus -, aperture +, aperture -, PTZ, PRESET, RECALL, BRUSH
F1, F2, F3	F1 is a key to start functional test

二. Device and Installation

1. Installation

1.1: Open the protective cover

Turn the electric lock located on the front panel anti-clockwise to unlock it and open the protective cover.

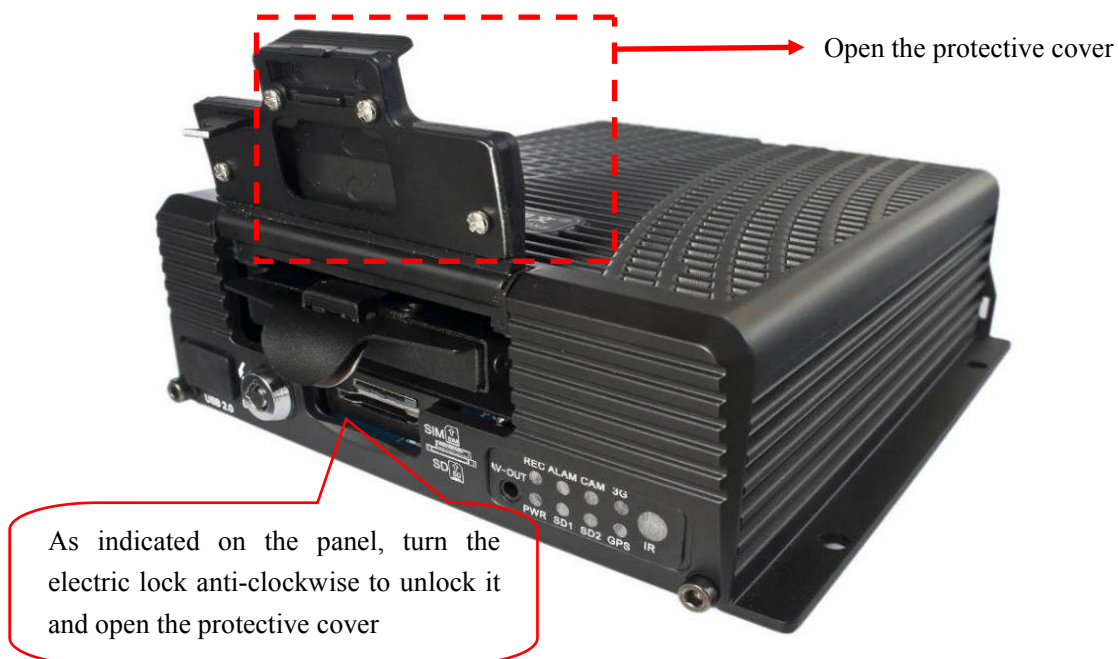

1.2: Prepare the HDD

Insert the prepared HDD into the HDD box and fix it.

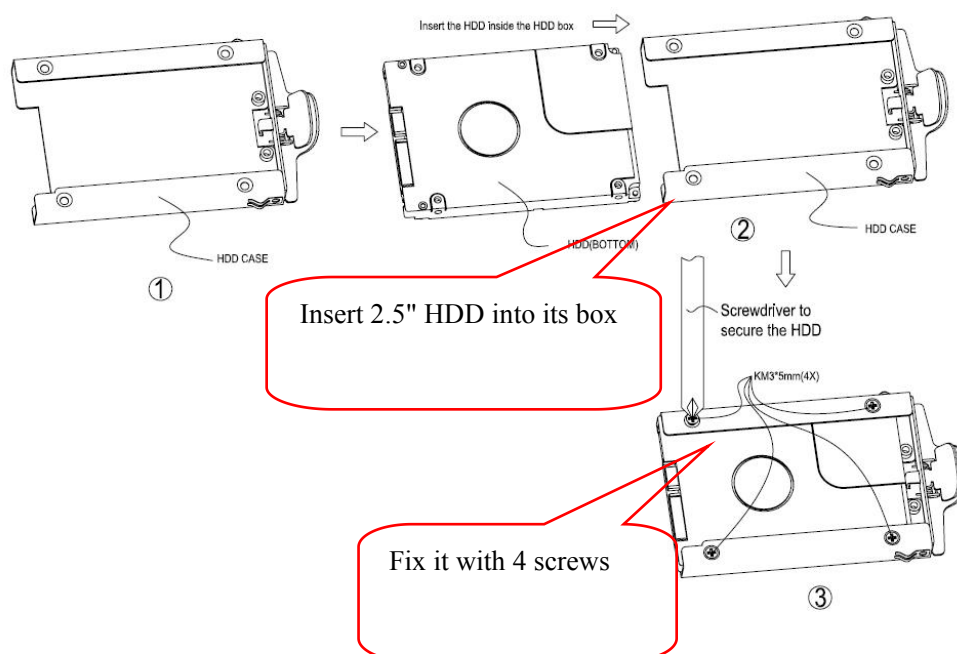

1.3: Insert the HDD

Slowly insert the machined HDD by aligning with the HDD box until you hear a "click" sound.

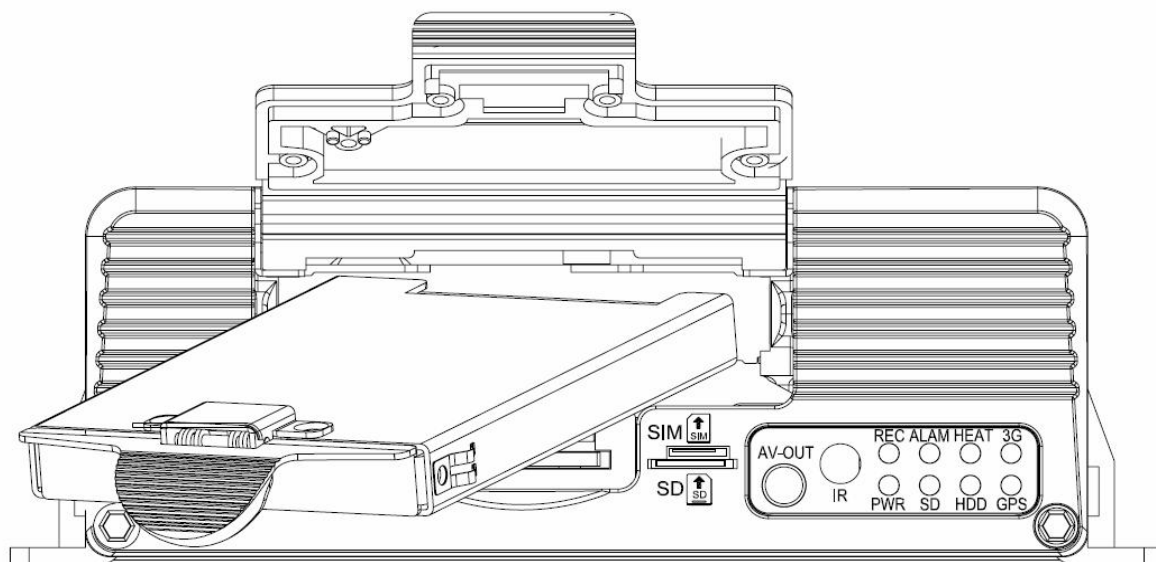

Take the HDD out of its box by holding the box handle and then pull it out, as shown in the figure:

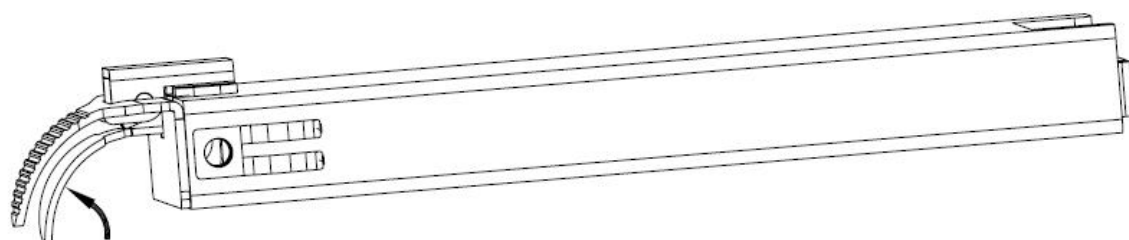

Push the shrapnel

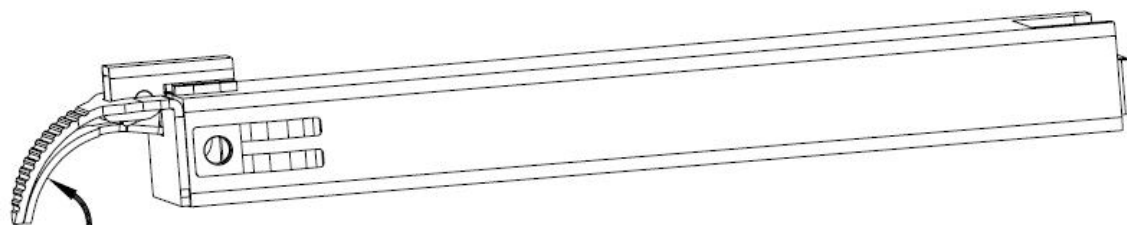

The need to get this effect

1.4: Install SIM and SD cards

As indicated on the panel, install SIM card and SD card into its respective place. According

to the device's communication configuration, install the related SIM card, such as WCDMA (China Unicom), EVDO (China Telecom) or TD-SCDMA (China Mobile) in 3G version, as well as TDD-LTE or FDD-LTE in 4G version. The SD card is mainly used to back up video files when the HDD is exceptional (the SD card is located on the communication board and only present in models with 3G/4G/WiFi module supported).

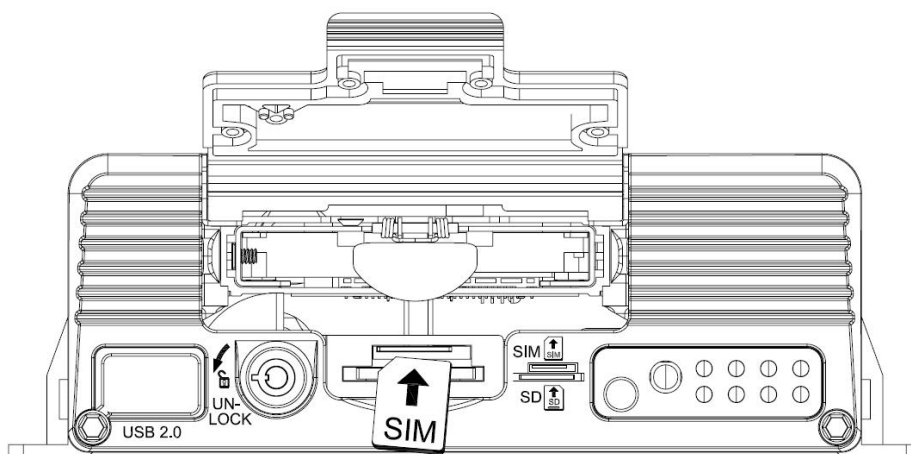

1.5: Lock the electric lock

After all units are installed, close the protective cover, and then turn the electric lock clockwise to lock it; otherwise, the device cannot be powered on. In the equipment working normally, please do not open the electronic lock, otherwise the machine automatic shutdown delay 3 to 8 seconds.



1. 6: Install the mainframe

According to indicated MDVR mounting hole size, install the device in a proper place of the vehicle.

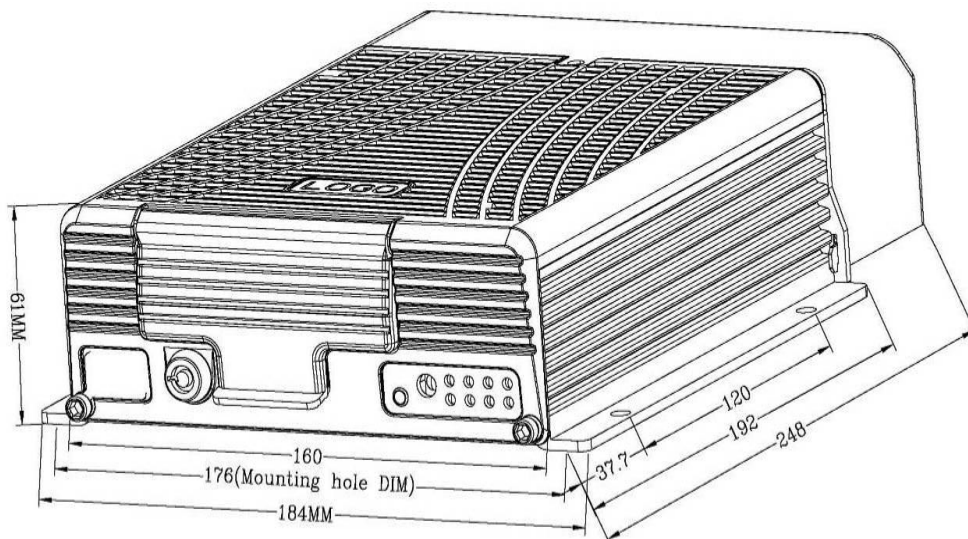

1. 7: Install GPS, 3G/4G, WiFi antenna

As shown in the following figure, connect GPS, 3G/4G and WiFi antenna to corresponding interface on the rear panel of the MDVR and keep wires well arranged to protect the signal from external interference.



GPS



3G



4G

1. 8: Connect the power cord

Connect the air power cord to 6PIN power input interface on the rear panel of the MDVR (If it is in white, the 6pin cable shall be connected with an adapter), while the red and black cables are directly connected to the battery of the vehicle, i.e. positive terminal and negative terminal respectively. The yellow cable is connected to ACC, the vehicle control circuit switch (used to start the vehicle motor). The unit will be enabled automatically when the car key is enabled and disabled when the key is disabled.

When the device is not installed in a vehicle (such as monitoring systems in bus station, logistic transfer) or under test, you can use a switching power above DC12V-5A to supply the mainframe. In this case, twist the red and yellow cables as a cable to connect it to the positive terminal, while the black one is connected to the negative terminal separately.

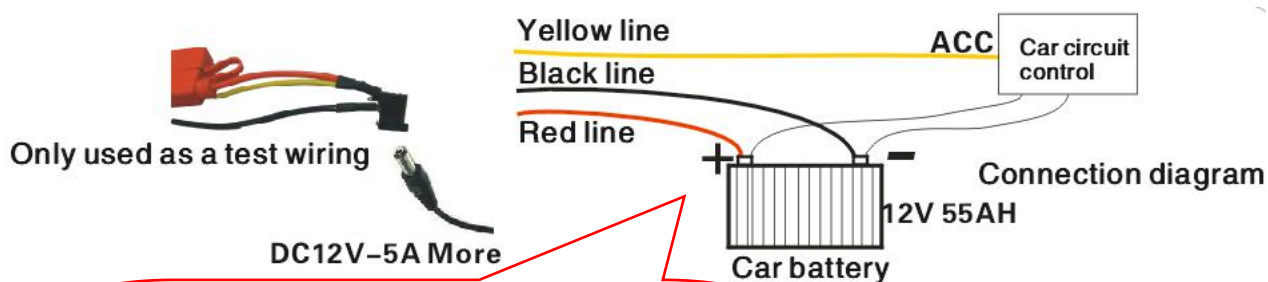
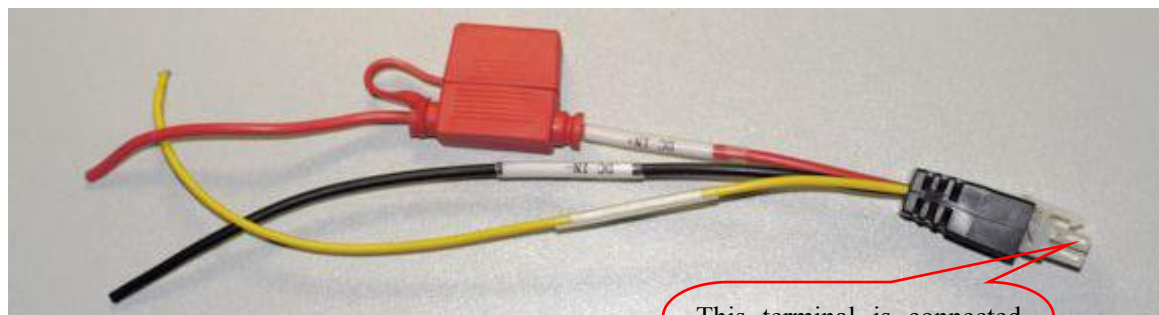

Before connecting, check that the voltage ranges from 8V to 36V. If not, the device will be suspended.



It is suggested that the vehicle mounted machine be directly powered from positive and negative terminals of the battery cell, or led from the mains power at the fuse without use of ground strap, which may influence normal operation of the mainframe due to negative pulse; The power cable used for positive and negative terminals shall have diameter of $\phi 1.5\text{mm}$ or above.

1. 9: Connect the display output unit

This product supports two CVBS video outputs (one is $\phi 3.5$ Phone Jack on the front panel, and the other is 24PIN connector). A customer can connect to the display unit according actual conditions. Connect the 3-in-1 terminal of the supplied 4pin-AV output cable to the $\phi 3.5$ Phone Jack on the front panel, and the other terminal to the display unit.

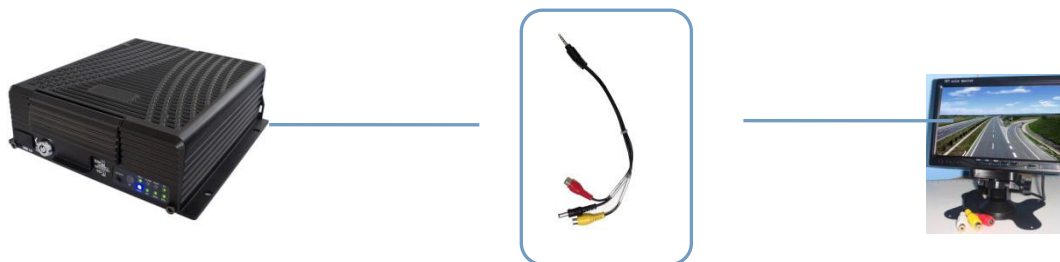

1.10: Alarm input and output cable

A: Sensor input alarm cable

Connect the external sensor to set with alarm feature to 8 external alarm input ports of the I/O sensor on the rear panel of the MDVR. The external alarm inputs shall be connected to related sensor switching units, such as door magnet power, emergency switch, turn signal switch and brake light, as shown in the following figure.

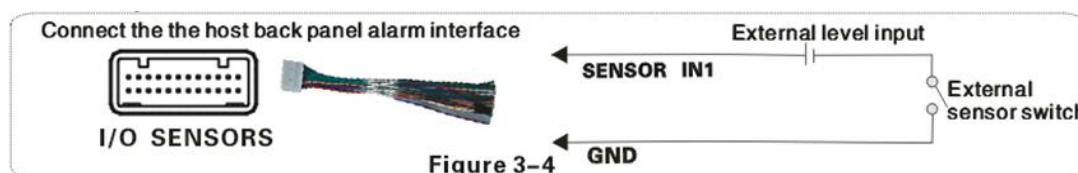

For example: the following block diagram shows that high level is detected when the brake pad is stepped down; otherwise, low level will be detected. Thus, braking operation may trigger device alarm.

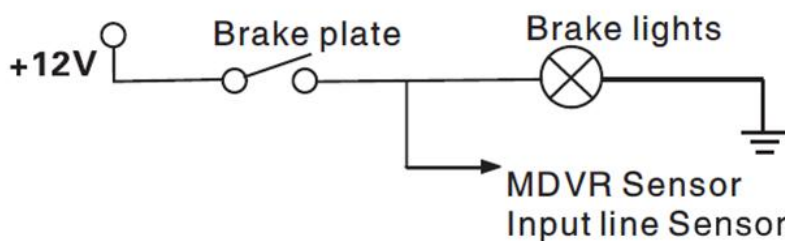

B: Over-speed alarm cable

a: If a speed is acquired from GPS, requiring normal GPS signal, the alarm feature can be enabled by simply configuring settings via Setup menu -> Alarm -> Speed.

b: If a speed is acquired from the vehicle, the over-speed alarm feature can be enabled by connecting it to the speed pulse sensor. The pulse sensor is connected to SPEED-A and GND cables of the device, as shown in the following figure:

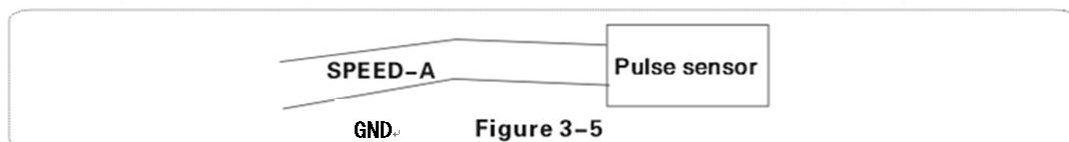

C: Alarm output cable

This device provides one alarm outputs and uses 20MA to drive external alarm units. If you expect to drive a device with higher power, connect an external electrical appliance, as shown in the following figure.

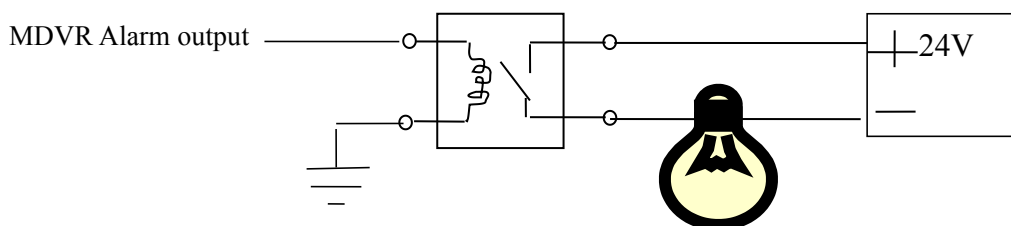

1.11: RS232/RS485 device connection

This product provides two RS232 serial ports, to which a user can connect the desired sensor, OBD and two-way radio supporting RS232 according to actual requirements. Before installation, firstly connect the power cord and communication cable of the external device to the supplied 24pin I/O port, and then to 24PIN I/O port on the rear panel of the vehicle MDVR. Finally, install the probe for the external device and keep cables well arranged. The following shows the schematic connection diagram:

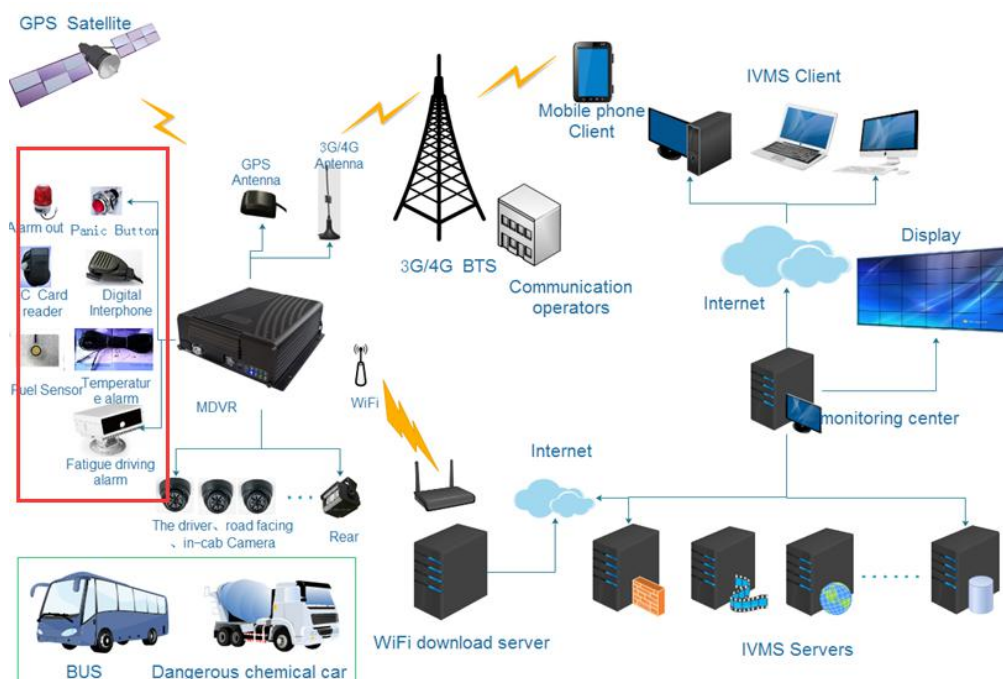

1.12: Connect PTZ

There are three methods for connecting PTZ in terms of PTZ control method:

- The first method is connect the RS485 control cable of the PTZ to the RS485A and RS485B of the main frame, connect the video cable to the mainframe video input, and then power the PTZ. At the same time, configure the PTZ setting corresponding to PTZ data under the peripheral setup option to use the remote control to control the PTZ.

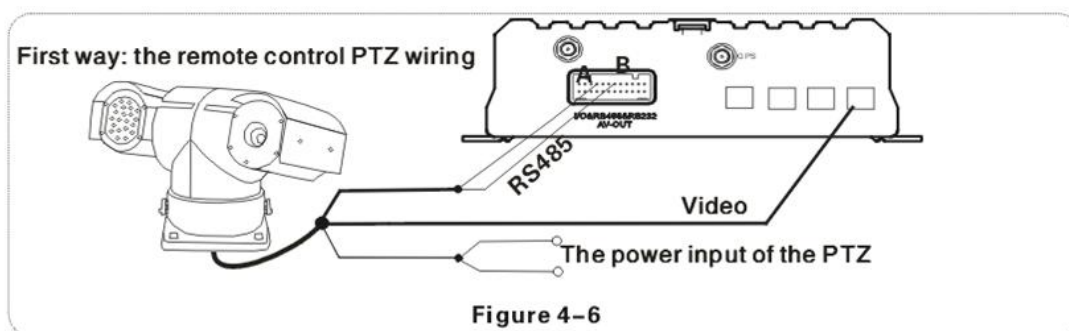

After the PTZ is connected and parameters are set, you shall select the channel connected to the PTZ before using the remote control to control the PTZ. For example, if the PTZ is connected to Channel 2, then you can control it only after switching the monitoring interface to Channel 2 and maximizing it.

- The second method is to directly connect the RS485 control cable of the PTZ to 3D control keypad, connect to the video cable to the mainframe video input to power the PTZ and 3D keypad, and then set keypad parameters corresponding to the PTZ. Thus you can use the 3D keypad to control the PTZ, with higher speed and efficiency than the remote control.

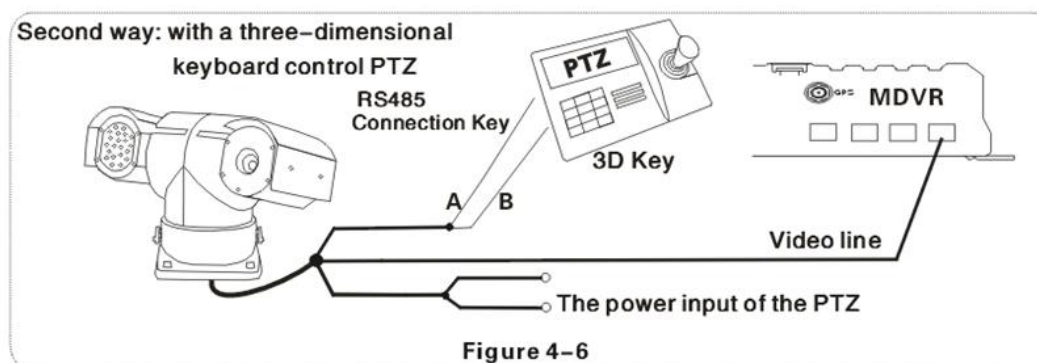

- The third method is to combine these two connection methods by connecting both vehicle mainframe and 3D keypad to control the rotation of the PTZ to realize even remote control.

2. Connection Method of This Solution

This product is suitable for video monitoring or remote monitoring and applicable for general or special vehicles. It mainly uses the special designed vehicle camera to acquire the front video signal, then transmits the signal via a special video cable to the MDVR mainframe for video compression and image processing and finally stored in the HDD. It can also locate where the vehicle is in real time via GPS module, and then upload the location information to the remote server via 3G/4G module. You can download video files from the remote client to realize real-time remote monitoring of the vehicle. The following shows the actual application model of this product that may be different depending on vehicle type and peripherals.

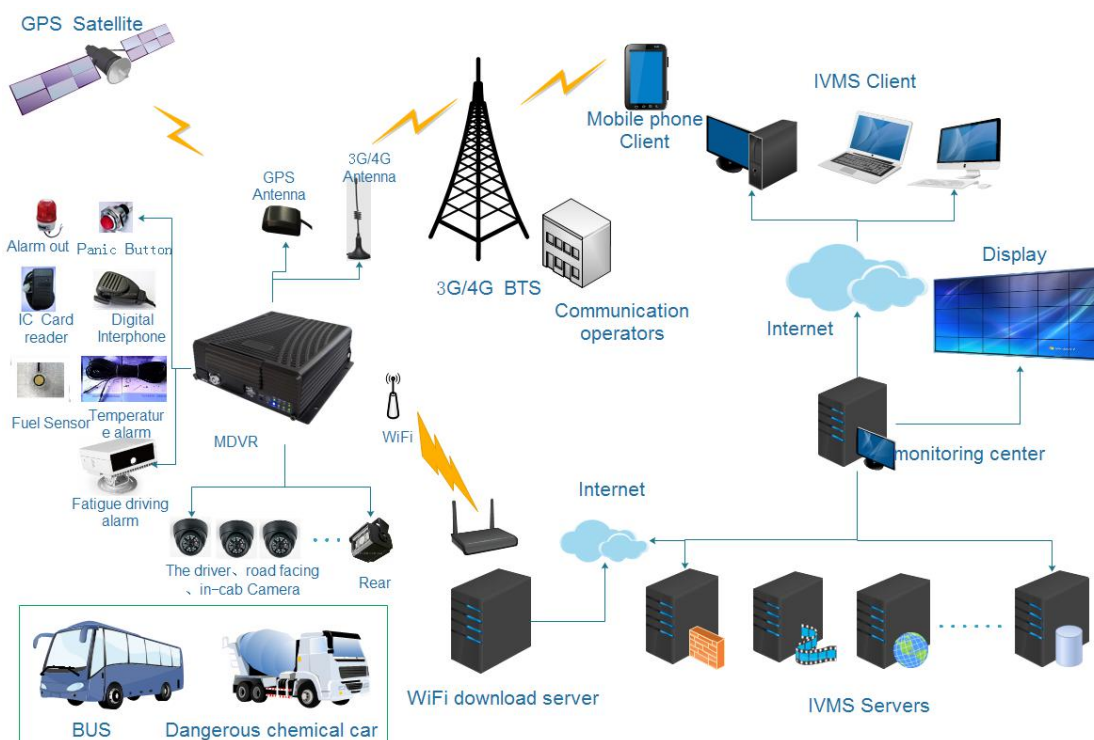

三. Basic Settings

After the power supply is connected to the vehicle start circuit, ensure that the device will automatically start when the vehicle is started if the power supply is properly connected to peripherals. The system enters the Quad View after start, where you can press the Login key on your remote control to input the Admin password (888888 by default) to enter the setup menu and configure related settings to meet vehicle management requirements.

The Setup menu has 8 options including: General, Channel Mode, Record, Alarm, Tools, Peripherals, Search and System Info (as shown in the figure). The following section will individually introduce related setting methods.

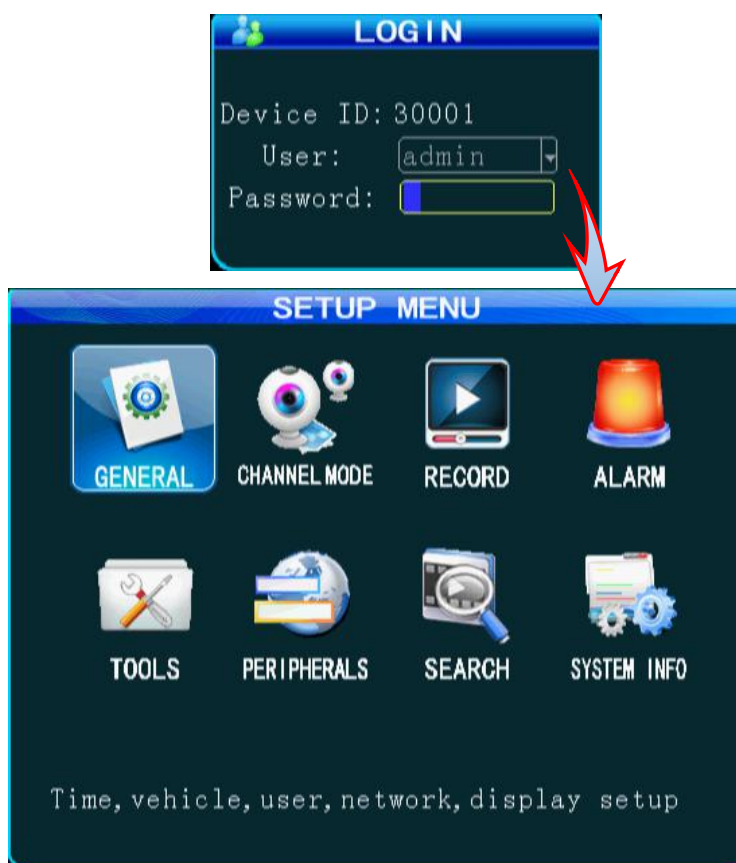

1. Basic Setup:

1.1: Basic Setup

From Setup menu, press the "ENTER" key to enter the General interface, where you can set desired date and time, vehicle information, user management, network ,code OSD and display.



1.2: set Date & Time

From the General menu, select "Date & Time" to enter its interface.

If GPS timing mode is selected, the time will be updated at the timing point.

According the connection method of the installed power supply, select the default ignition mode, where you can set the recording delay time after shutdown

DATE TIME

Date Format DATE MON

Time Format Time

Time Zone +

DST Switch ON DST Adjust

Start End

Screen off

Time Mode

Time Check

Power Mode

Power Off Delay (0-1440mins)

Maintenance ON Time:

Power Off Voltage (8-11.4V)



1. It is advised to enable the auto-maintenance feature when the device is operating for a prolonged time, allowing that the device automatically restarts within the set maintenance time.
2. OPR Timeout meaning the quit automatically time if you don't operate, Other options are set as required and after setting.

1. 3: Set Vehicle INFO

Press the "Return" key to return to the General menu to enter the Vehicle Info menu. To facilitate unified management of vehicles on the server, it is recommended to completely fill in vehicle information.

The server will monitor and manage vehicles through device number. When vehicles are managed via 3G/4G network, please ensure the uniqueness of the device number.

Please ensure your vehicle number is correct which will be superimposed on the video.

The screenshot shows a menu titled "VEHICLE INFO" with the following fields and values:

- Serial-Num: 0000-0000-0001-d54f
- Dev-Num: 30001
- Department: (empty)
- Driver Name: TOM
- SIM-Num: (empty) Login IVMS
- Mile Accrual: OFF
- Mileage: 000000KM [MODIFY]
- Vehicle-Num: (empty)

A "SAVE" button is located at the bottom right of the screen.



1. The report can be founded on the IVMS client only when the mileage statistic is started;
2. After setting, move your cursor to the "Save" key and press the "ENTER" key to save

1. 4: User Setup

Press the "RETURN" key to return to the General menu to enter the User Setup menu and to switch the password enable on. The original admin password is 888888. If the password is changed, the password is required when restarting to enter the system setup menu.

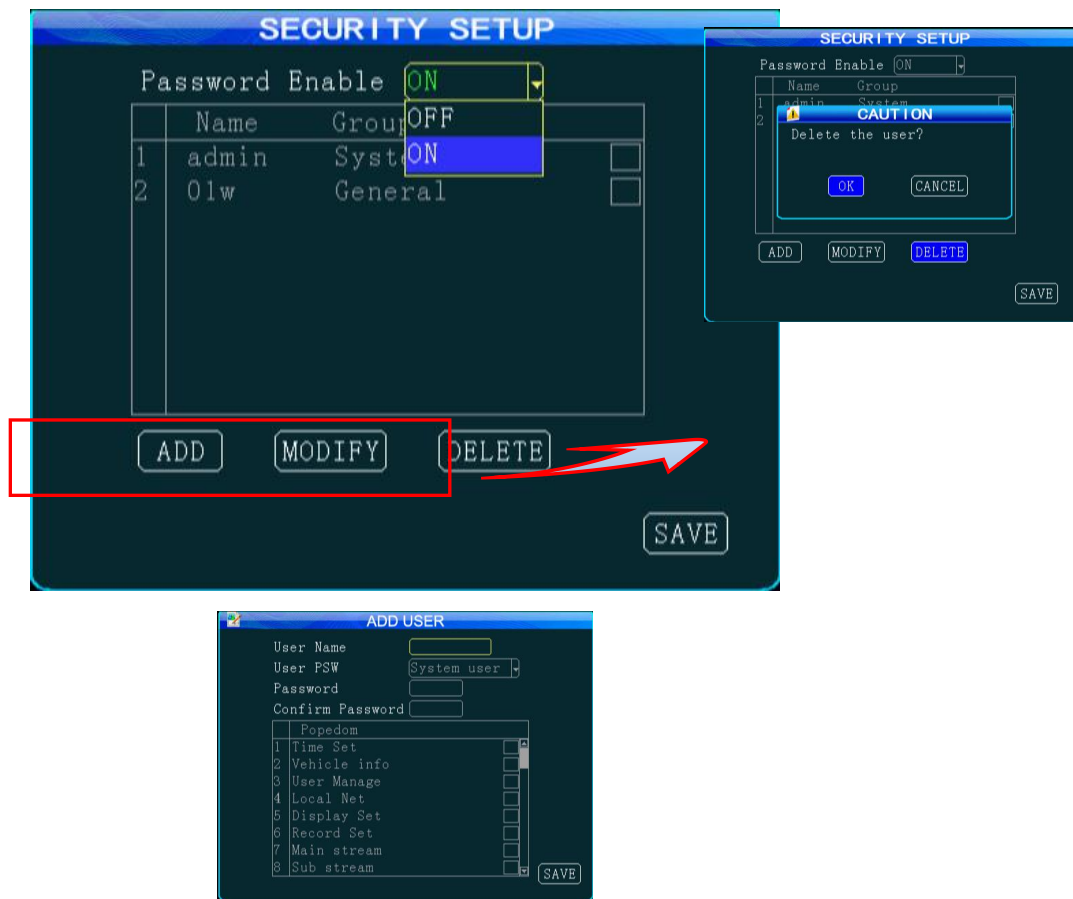

1. You can add, modify or delete a user, or set user permission.
2. After setting, move your cursor to the "Save" key and press the "ENTER" key to save it.

1. 5: Network Setup

Press the "Return" key to return the General menu to enter Network Setup interface.

The screenshot shows the NETWORK SETUP interface with the following fields:

- IP Addr: 192.168.000.250
- Netmask: 255.255.255.000
- Gateway: 192.168.000.001
- MAC Addr: E8:31:CF:56:71:80
- Net Mode: IP
- Server Addr: 120.024.066.218
- Control Port: 6608
- Intercom IP: 192.168.000.152
- Intercom Port: 1111
- IcCard IP: 192.168.001.152
- IcCard Port: 19000
- SAVE button

Callout boxes provide the following instructions:

- Top Callout:** If an external IPC is selected, the IP network segment here shall be the same as that of the connected IPC. The gateway address is set to the first IP address of this segment, such as 192.168.000.001.
- Bottom Callout:** When the device is reported to the sever via 3G/4G network, or is connected to the two-way radio, the related IP, port and protocol type shall be set.



1. The two-way radio has the port number of 9988, while this parameter is unavailable for an analog two-way radio.
2. A dynamic IP is assigned to the server, rather than a fixed IP, "Domain Name" is selected as the connection mode. In this case, a fixed IP is more stable; thus, it is not advised to use domain name mode.
3. A customer can establish its own server or use a server provided by the manufacturer. If a server (including intercom server) provided by the manufacturer is required, please contact our technical support, which will provide the assigned device number, server IP, related user account and password to the customer. The customer shall simply fill these parameters into the related fields.
4. Fill in the IP and port number of the department standard platform when being reported to it, while it is not required for this product (JH8-HD)

1. 6: Display Setup

Press the "Return" key to return the General menu to enter Display Setup interface.

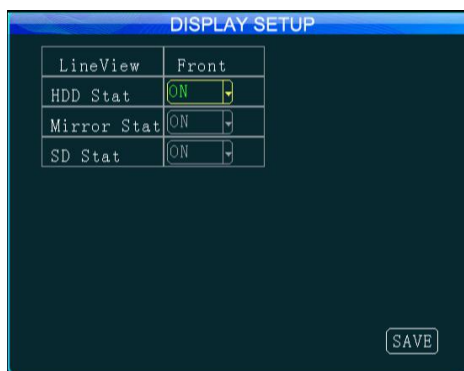
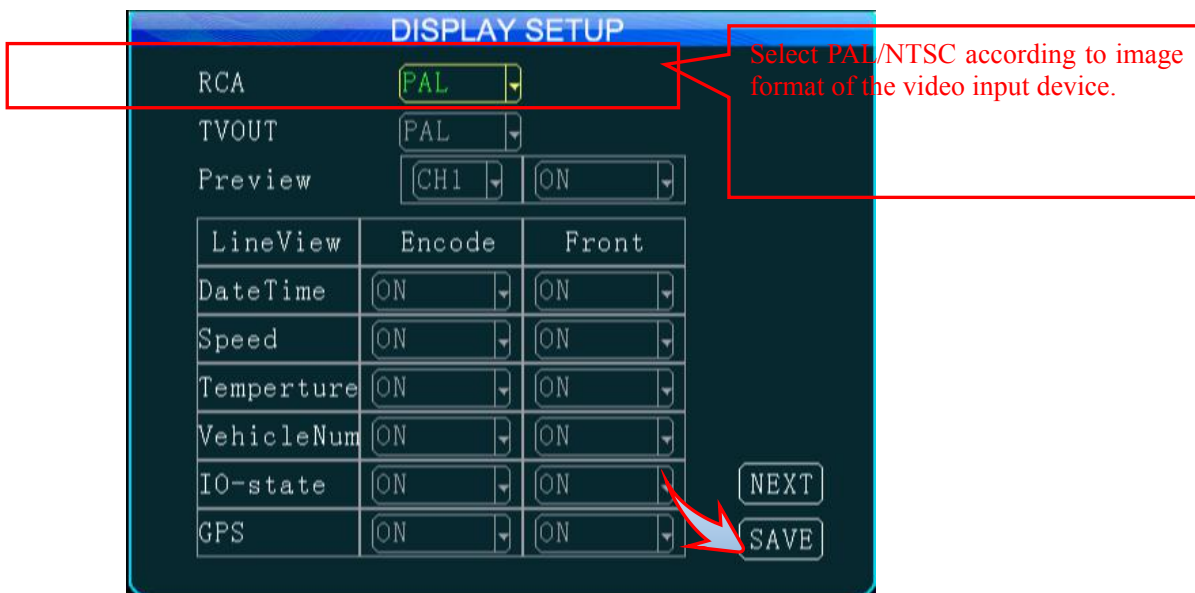

1. Preview of videos on the screen; you can set date&time, speed, HDD temperature, vehicle number, IO alarm state, and GPS information to on or off during video encoding or screen display.
2. Select PAL/NTSC for the output format as required and after setting, move your cursor to the "Save" key and then press the "ENTER" key to save it.

1.7:CODE OSD

Click the "RETURN" key to RETURN to general Settings menu, enter the CODE OSD.

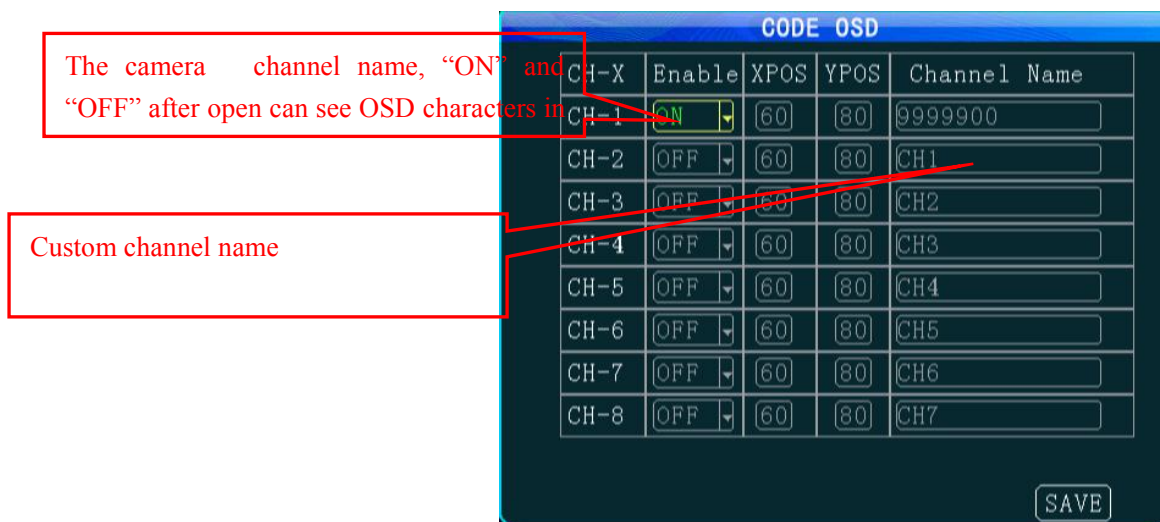

2.Channel Mode

Press the "Return" key twice to return to the setup menu and select Channel Mode where you can select different channel modes depending on the model you use. The device will restart if a mode is switched to the other. This product is a hybrid HD vehicle MDVR supporting several types of camera connection. The interfaces for the analog camera are defined as follows and the standard interface is for the IP camera. A user can select the proper camera type and configure software properly according to hardware connection mode.

Connection Diagram	Pin Number	Interface Definition	Pin Number	Interface Definition
	1	12V OUT	5	A-IN-2
	2	GND	6	V-IN-2
	3	A-IN-1		
	4	V-IN-1		

- Camera Connection Mode

AL3000-HD Connection Mode

Connection Mode	Connection Diagram	Model AL3000-HD
Connection of single analog camera		8 channels of CIF/ D1/960H /720P AHD analog video inputs available

Mixed connection of analog and network cameras		1 channel of 1080P IPC+8*720P AHD/960H/D1/CIF HD mixed video inputs available
--	---	--



3. Record Setup:

3. 1: Enter the Record Setup interface

Press the "Return" key twice to return to the Setup Menu, where you can configure record settings, including general settings, main code, sub-stream, recording schedule, mirror recording, SD recording and IPC setting.



The IPC setting interface is not present when only an analog camera input mode is selected.

3. 2: Record Basic Setup

From the Record Setup menu, select the General option and press the "Enter" key to enter the Record Basic Setup interface, where you can select the desired recording mode as required. The

record packet time can be set to 15 min, 30 min, 45 min or 60 min.

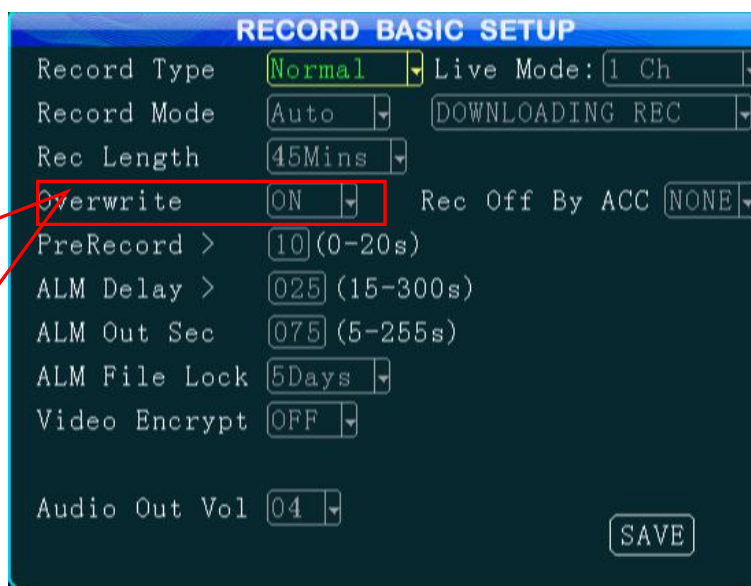

When this option is enabled, when the HDD space is lower than 2G; When the space of mirror record HDD and SD card is less than 300M, the early videos will be automatically overwritten.



1. When the alarm record option is selected, you can set the pre-record time, alarm record delay time, alarm output time and alarm lock time. When timing record is selected, you shall set the record schedule (for details, see 1. 5).
2. After setting, move your cursor to the "Save" key and press the "ENTER" key to save it.

3.3: Main Code

Press the "Return" key to return to the Record Setup menu to enter the Main Code setting interface, where you can set the main code of the external analog camera. Resolution D1/HD1/CIF/960H/720P are available for choice.

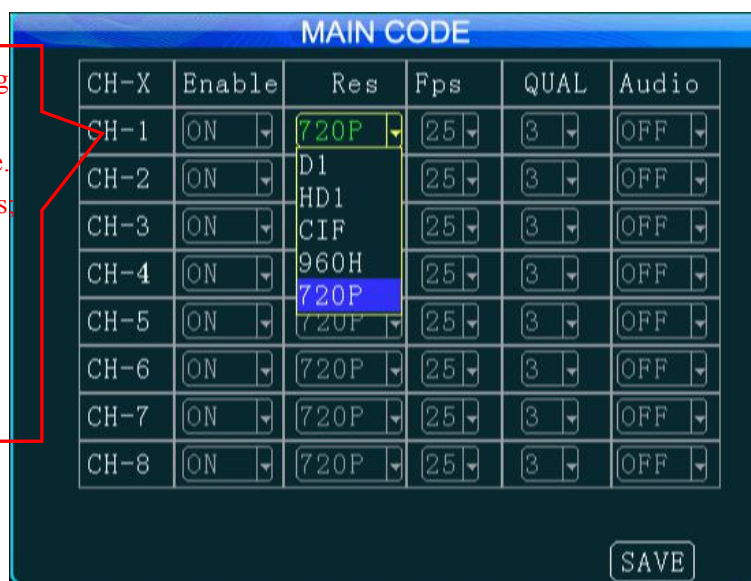

1) The frame rate is adjusted according to image format. The higher the frame rate is, the better the timeliness will be. PAL is adjustable between 1-25 frames. NTSC is adjustable between 1-30 frames.
 2) Level 8 indicates the lowest picture quality. The higher the picture quality is, the better video definition will be.



1. Enabling of the record feature requires an external pickup or the camera is provide with a pickup.
2. If only IP camera input is selected, only IPC setting is required;
3. After setting, move your cursor to the "Save" key and press the "ENTER" key to save it.

3. 4: Sub-Stream Setup

Press the "Return" key to return to the Record Setup menu to enter the Sub-stream setting interface. This setting is directly related to definition and fluency of video on the IVMS platform. The higher the resolution, the frame rate and bit rate is, and the higher the definition of the video will be. However, this requires more memory and broadband.

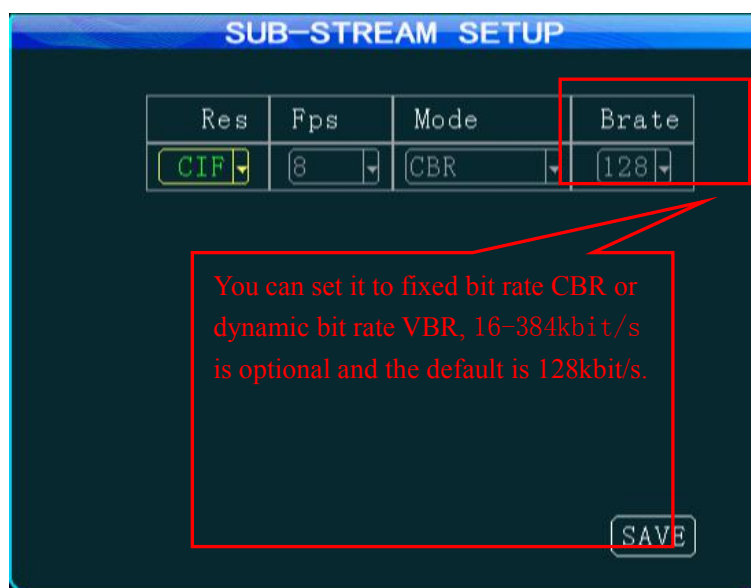

1. Either CIF or QCIF is optional for sub-stream resolution. Currently, the maximum CIF real-time transmission can be realized for 3G network;
2. After setting, move your cursor to the "Save" key and press the "ENTER" key to save it.

3. 5: Recording Schedule (to be set in timing record mode)

Press the "Return" key to return to the Record Setup menu to enter the recording schedule setting interface. If "Timing Record" mode (not commonly used) is selected under record mode in the General option, you shall set the record time frame here (two time frames can be selected).



1. The Recording Schedule shall be set only when the "Timing Record" mode is selected under record mode in the General option.
2. After setting, move your cursor to the "Save" key and press the "ENTER" key to save it.

3.6: Mirror Record(Customize)

Press the "Return" key to return to the Record Setup menu to enter the Mirror Record setting interface. Mirror record, as back record for the vehicle DVR, is used to prevent loss of records due to HDD error. (for details, please refer to 1.2 main code setting)



3.7: SD Record

Press the "Return" key to return to the Record Setup menu to enter the SD Record setting interface. When this option is selected, if the HDD is not present due to shock and SD record

feature is enabled, record files will be stored in the SD card.

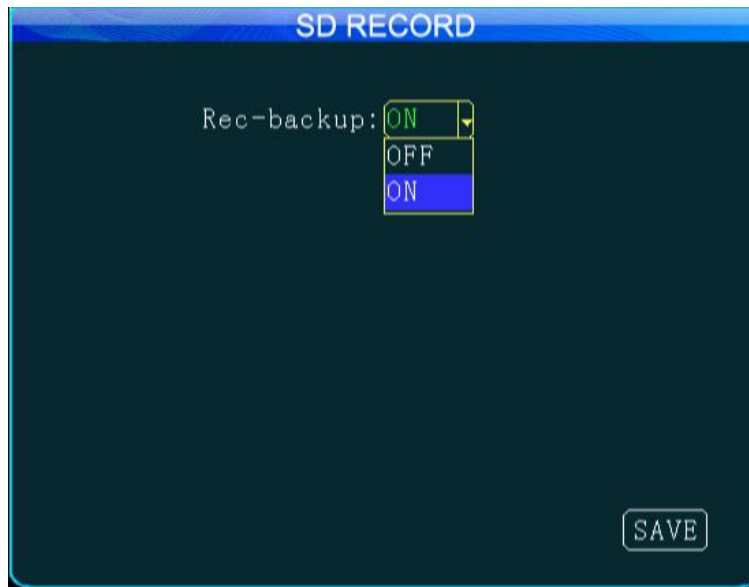

3.8: IPC

Press the "Return" key to return to the Record Setup menu to enter the IPC setting interface. Before setting, ensure that IPC is properly connected to the MDVR mainframe. You can click "Add", "Modify" or "Delete" option to add, modify or delete IPC parameters.



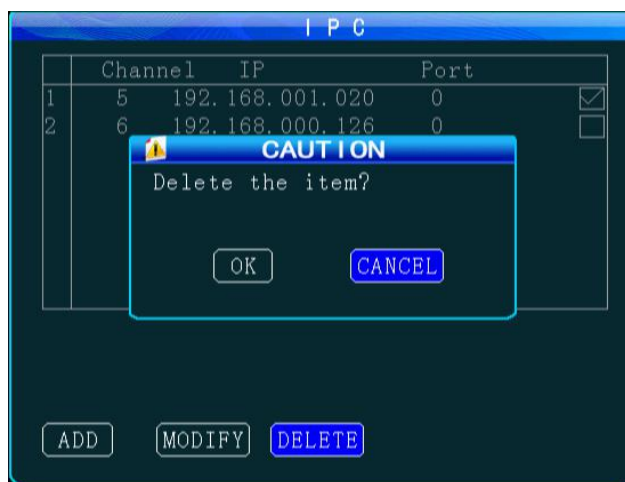

When adding a camera, select the related channel, and you can manually input the IP address and port number of the network camera or click "Search" to select the desired network camera in the search result. The user name and password are set for the network camera. For a network camera with security feature, the setting shall be the same as that for the network camera itself; or this setting can be ignored. Use your remote controller to move to the latter you want, press "Enter" to confirm your selection and press "Return" to return and complete your input.

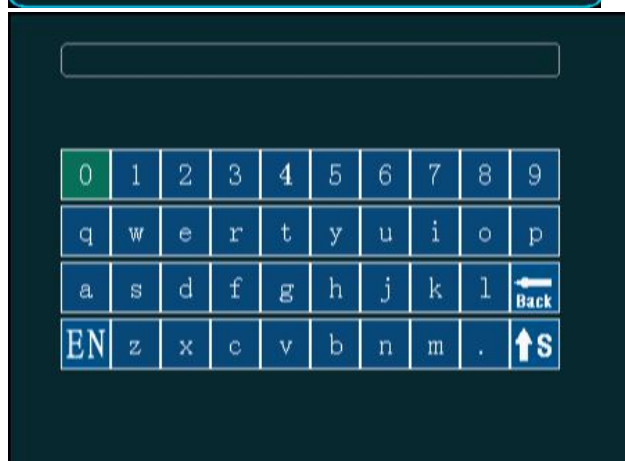
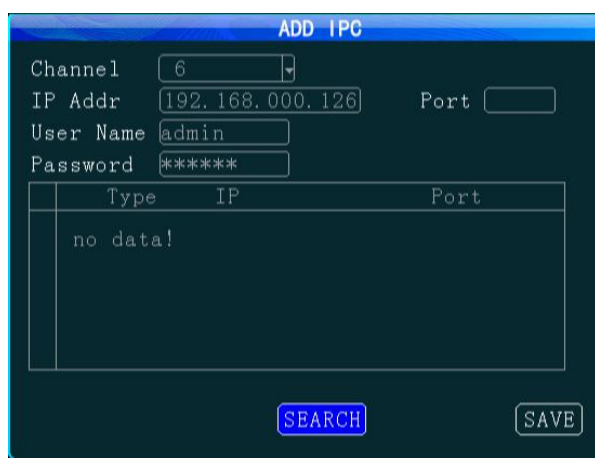



1. IP address and port number are those for the network camera itself. Be sure to keep them consistent when setting manually;
2. Clicking on "Search" will list all IP cameras connected to the MDVR;
3. After setting, move your cursor to the "Save" key and press the "ENTER" key to save it.

4. Alarm Setup:

4.1: Enter the Alarm Setup interface

Press the "Return" key to return to the Setup Menu and select the Alarm Setup interface, where you can set sensor, speed, acceleration, temperature, motion detection, ALARM OUT setting, motion and other alarm modes. The alarm feature can be used only when an external sensor is connected. The alarm feature is enabled when following enable settings are on. If "Event" is selected for alarm type, normal recording is conducted. If "Alarm" is selected, alarm record is conducted; the threshold indicates the speed limit when the alarm is triggered.

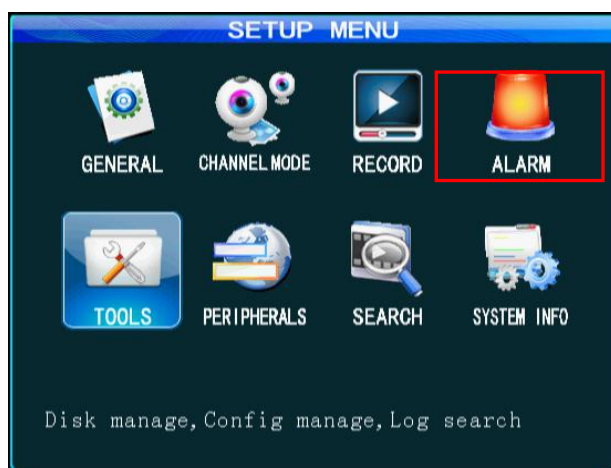

4.2: Sensor Setup

From the Alarm Setup menu, select the "Sensor" menu and press the "Enter" key to enter the

sensor alarm setting option. This product support 8 channels sensor-in, You can set the desired sensor name as required.

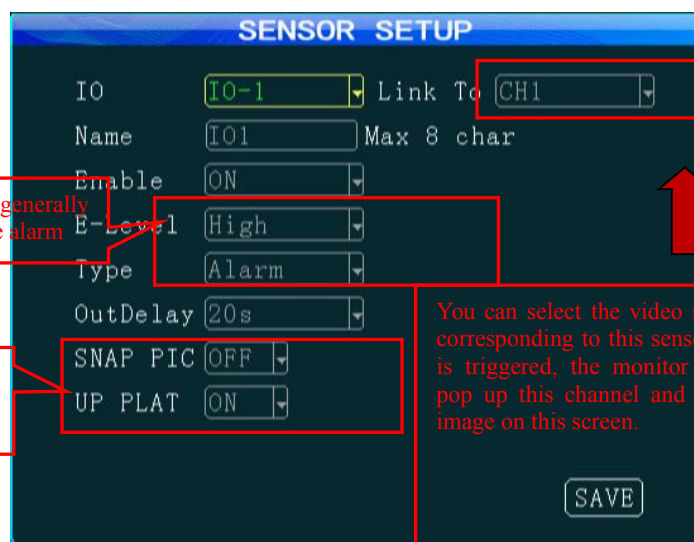

When Enable is set to "ON", a user generally uses high level over 5V to trigger the alarm

Snap is set to "ON", can trigger the alarm after capturing images to upload photos

You can select the video monitoring channel corresponding to this sensor. When the alarm is triggered, the monitor will automatically pop up this channel and magnify the video image on this screen.



1. Output delay indicates that alarm output is set in the alarm, i.e. when the alarm is off, the alarm outputs within the set delay time; After setting, move your cursor to the "Save" key and press the "Enter" key to save it.

4. 3: Speed Setup

Press the "Return" key to return the Alarm Setup menu to enter Speed Setup interface.



1. Keep the signal stable when selecting GPS; connect the pulse sensor to the SPEED-A and SPEED-B. The speed can be in KMH/MPH;
2. After setting, move your cursor to the "Save" key and press the "ENTER" key to save it.

4. 4: G-sensor Setup

Press the "Return" key to return to the Alarm Setup menu to enter G-sensor Setup interface.

When transient acceleration is high during braking, turning, acceleration or collision, it indicates the threshold value changes fast.

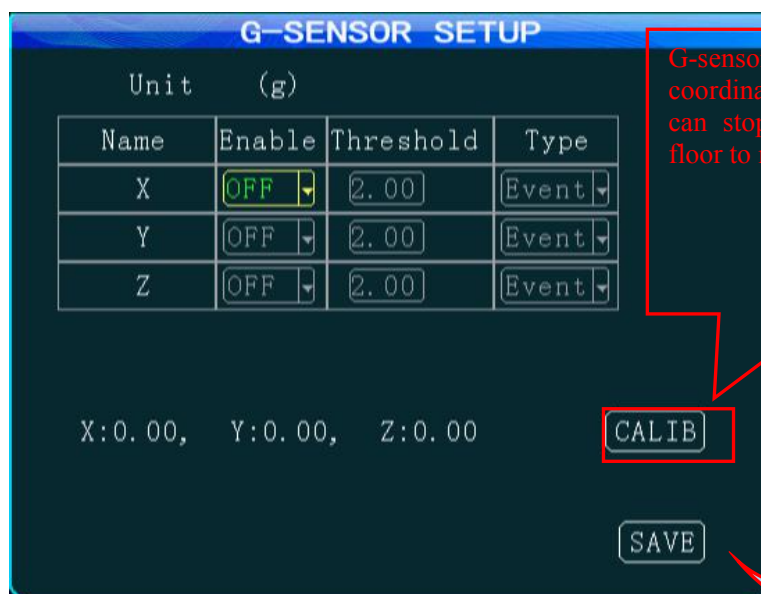

G-sensor alarm requires coordinate correction firstly. You can stop your vehicle on a flat floor to reset it.

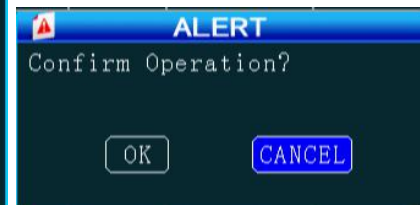

4.5: Temperature Setup

Press the "Return" key to return to the Alarm Setup menu to enter the Temperature Setup

interface. (unit: optional). If temperature alarm feature is enabled, this information can be transmitted to the central IVMS platform.



4. 6: ALARM OUT Setup

Press the "Return" key to return to Alarm Setup menu to enter the ALARM OUT Setup interface. You can select none/output 1/output2 from the ALARM OUT setup menu. 12V of high level is generated to drive other optoelectronic devices when the related alarm is triggered. (For detailed connection method, please refer to alarm input/output cable connection).

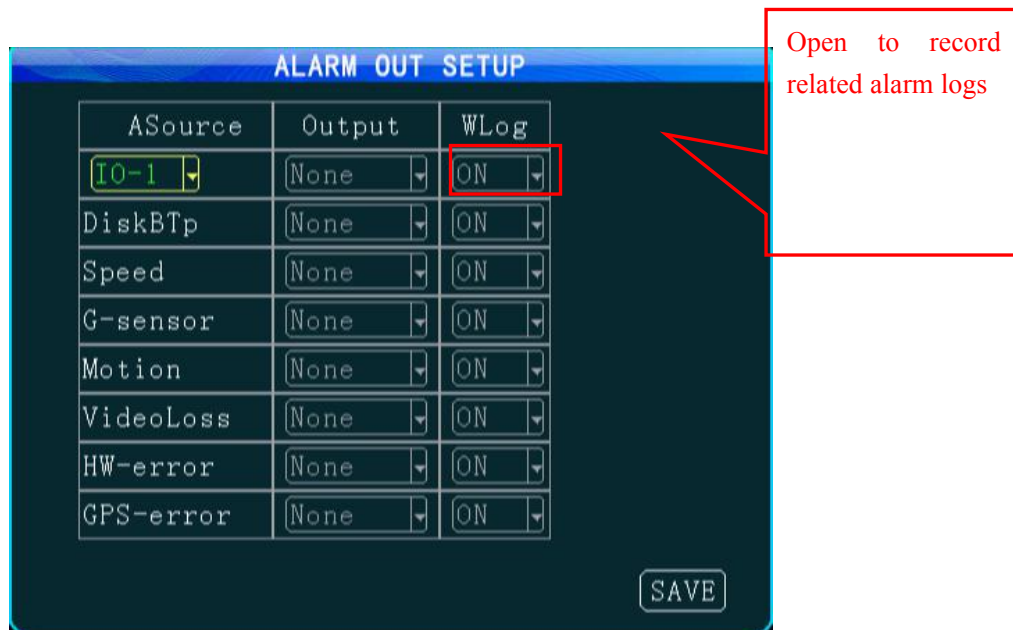

4. 7: Motion Detection

Press the "Return" key to return to the Alarm Setup menu to enter the Motion Detection

interface. Within the detection area, you can use your remote control to select two points as diagonal to define a detection area. Within the user defined area, when there is an object moving, the system will give an alarm when it is detected. A user can search motion detection alarm events under "Configuration -> Log Search", naming "CHL MD alarm".

The screenshot shows the "MOTION DETECTION" menu with the following table:

CH-X	Enable	Sensitivity	Area
CH-1	OFF	L	SETUP
CH-2	OFF	L	SETUP
CH-3	OFF	L	SETUP
CH-4	ON	L	SETUP
CH-5	OFF	L	SETUP
CH-6	OFF	L	SETUP
CH-7	OFF	L	SETUP
CH-8	OFF	L	SETUP

A red box highlights the "Area" column, and a red callout box points to the "OFF" status of CH-1 with the following text:

The environmental change may be detected more easily when the sensitivity is high; however, change of brightness and color will also trigger an alarm; thus, this alarm mode is not recommended.
 Detection area, you can use your remote control to select two points as diagonal to define the detection area.

A "SAVE" button is located at the bottom right of the screen.

The detection area is set as follow:

Select "Setup", and press the "Enter" key on the remote control to enter the motion detection setting interface,

Firstly: select the first block (yellow), and the motion block changes to blue after pressing the "Enter" key.

Secondly: select the second block and press the "Enter" key. The rectangular area formed by the diagonal of these two blocks is defined;

Thirdly: press the "Return" to return to the previous menu and press the "Save" key.

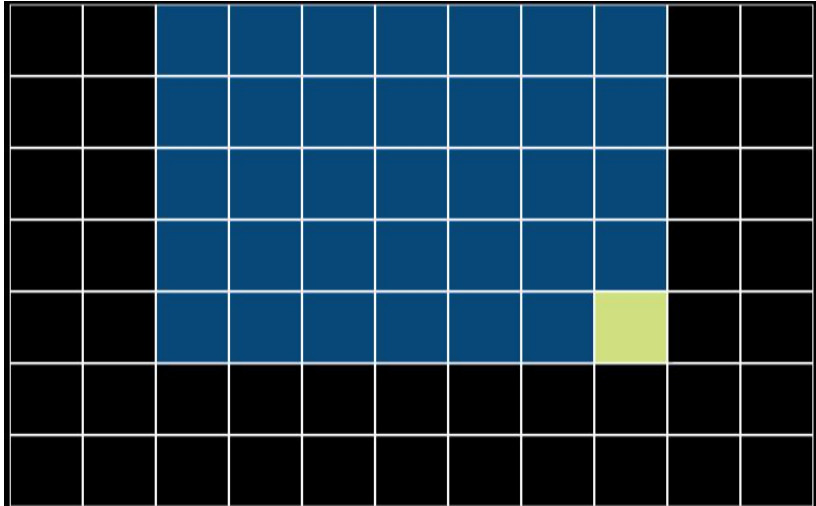

4. 8: Other Alarm

Click "RETURN" button to RETURN to alarm Settings menu, and enter the other alarm Settings interface, can set the timeout parking, fatigue driving time, more than set a time to make corresponding alarm;



5. Configuration:

5.1:Enter system tools

Press the "Return" key to return to the Setup Menu and select the configuration interface,Enter the system tools.

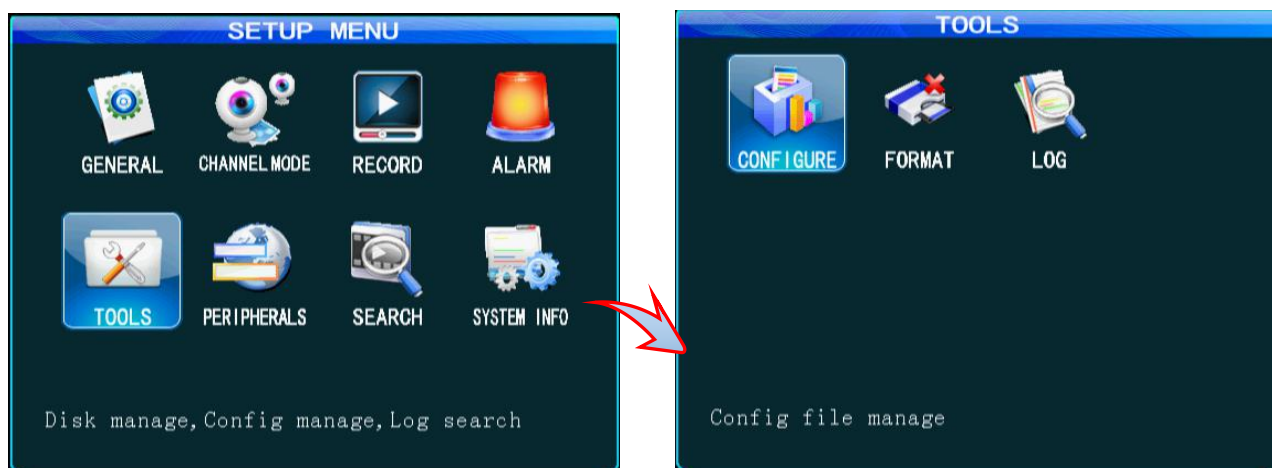

5.2: Configuration management

Press the "Return" key to return to the Setup Menu and select the "Configuration" icon to enter the Configuration interface, where you can import/export configuration through USB or recover default configuration.

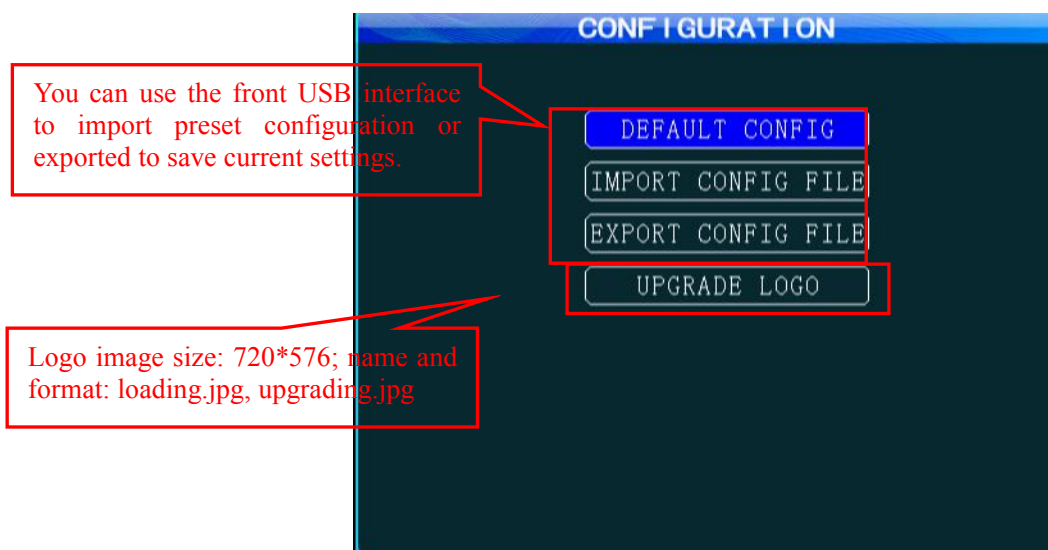

 1. 3G and WiFi shall be disabled before export, import, upgrading logo operation;

5.3: Formatting

Press the "Return" key to return to the Setup Menu to enter the Format setting interface, where you can select the storage medium to be formatted and press the "Format" button.

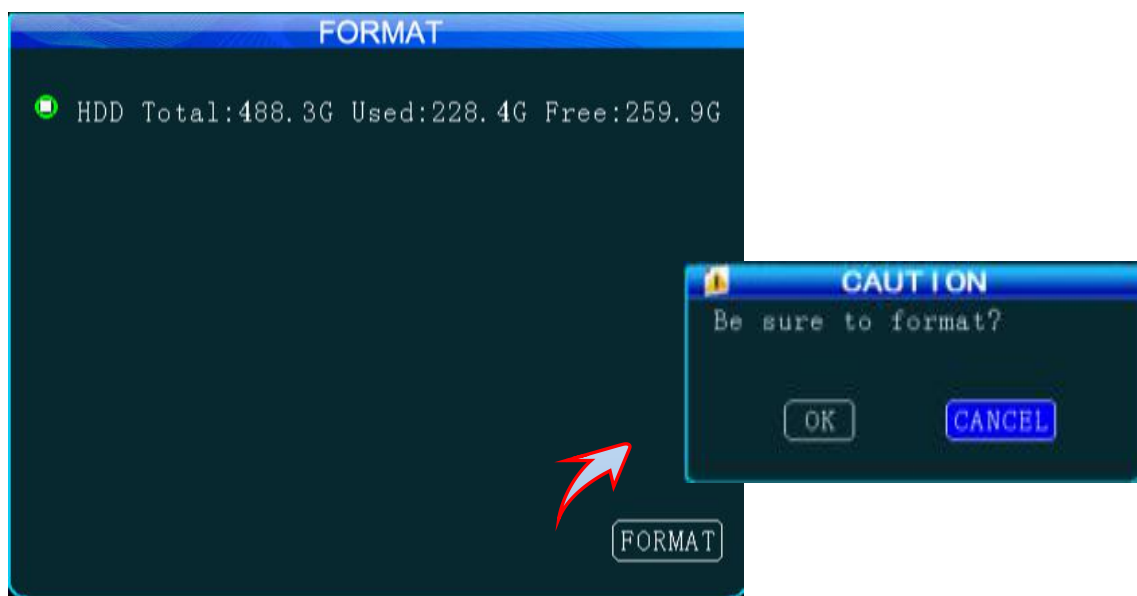

1. The HDD shall be formatted before being inserted into its box;.
2. Formatting will clear all data stored in the memory. Please check if there is important information before formatting.

5. 4: Log Search

Press the "Return" key to return to the Configuration menu to enter the Log Search setting interface.

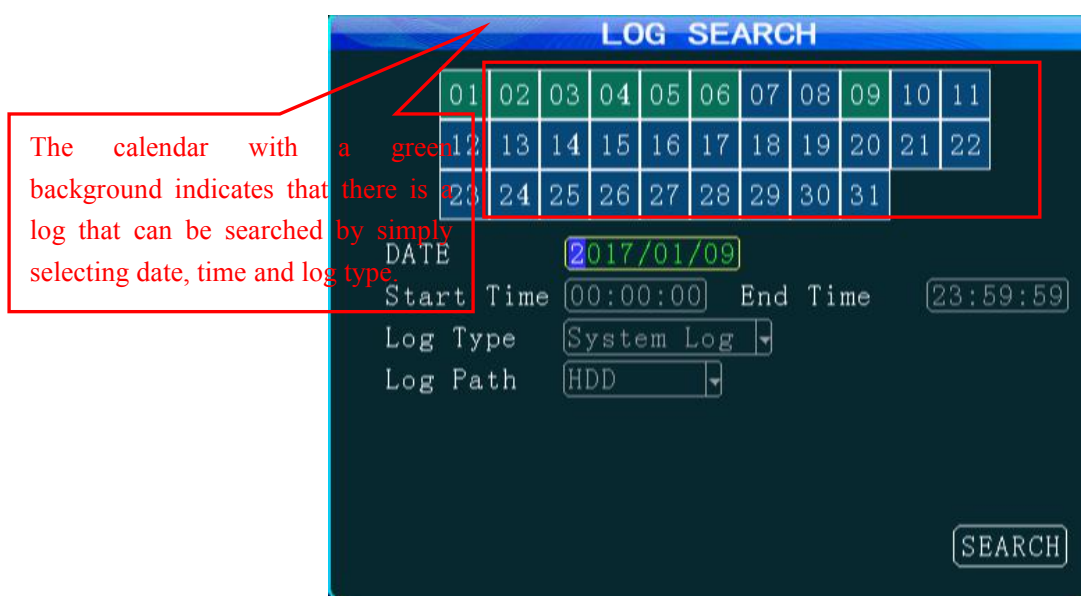

6.Peripheral Setup:

6.1: Enter the Peripheral Setup interface

Press the "Return" key to return to the Setup Menu to select the Peripherals icon to enter the Peripheral Setup interface, where you can set PTZ, wireless broadband, WiFi, Fuel, serial port.



6.2: PTZ

From the Peripheral Setup menu, select the PTZ icon to enter the corresponding interface.

Use default data bit, stop bit and check code.

After set the PTZ parameters, you should choose PTZ corresponding channels to remote control the PTZ, such as PTZ on channel 2, so in the monitoring interface need switch to the maximum 2 channel to control it.

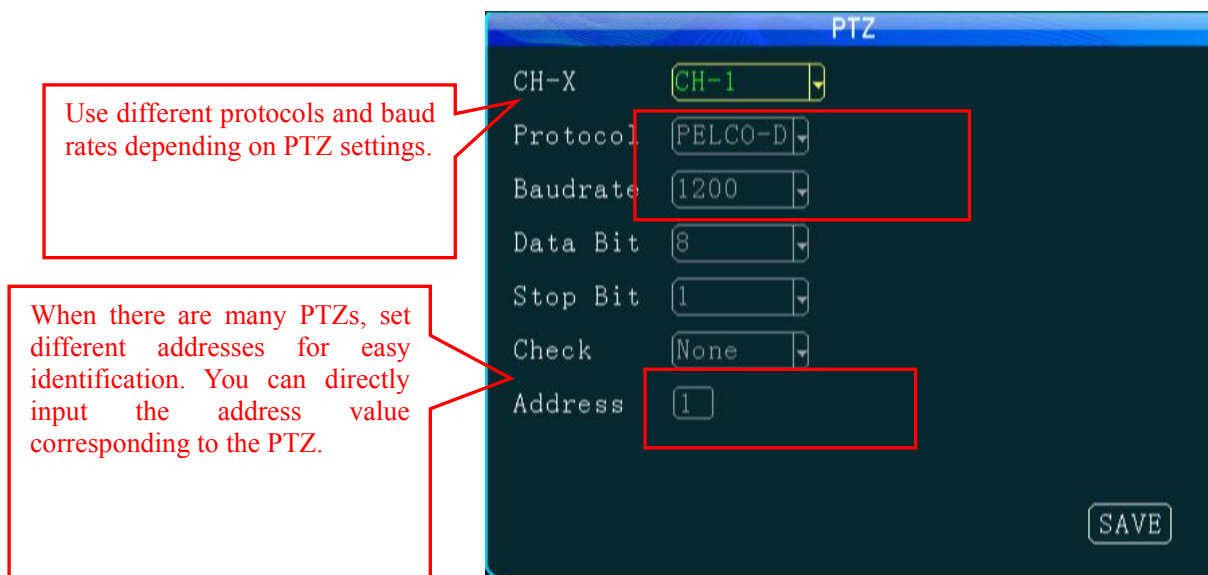

6.3: Wireless Setup

Press the "Return" key to return to the Peripheral Setup menu to enter the Wireless Setup menu. When 3G/4G SIM card is used in MDVR and information is reported to the platform via 3G/4G, wireless dial-up shall be enabled, and a proper communication type shall be selected according to operator's network format. There are some differences between 3G/4G software

versions, as shown in following figure. Use the default settings for domestic subscribers (the following figure shows default settings for China Unicom and China Telecom). For foreign subscribers, fill these fields with information provided by your local mobile network operator.

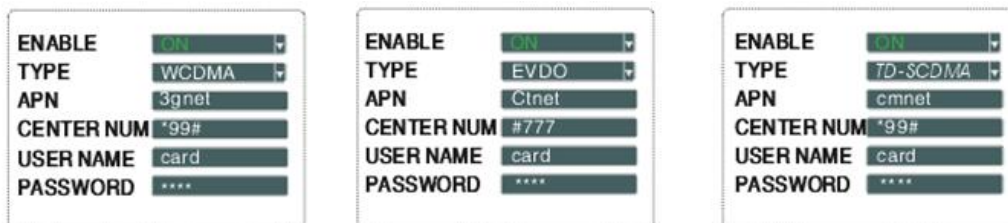

Interface for 3G software



Interface for 4G software



1. After exiting from all menus, pressing the INFO button on the remote control will show all 3G/4G-specific information. If the signal is normal, the dial-up operation is successful;
2. After setting, move your cursor to the "Save" key and press the "ENTER" key to save it.

6. 4: WiFi Setup

Press the "Return" key to return to the Peripheral Setup menu to enter the WiFi Setup interface where you can input the desired IP, SSID and submask of your WiFi. The device will check the RJ45 is successfully connected to the external module.

Select as required

The WiFi auto-download server checks if WiFi connection is used via this SSID.



1. After SSID of the MDVR is set, a corresponding SSID is also required when adding the appropriate WiFi download point to realize WiFi auto-download;
2. Other options are set as required and after setting, move your cursor to the "Save" key and then press the "ENTER" key to save it.

6.5: Fuel Setup

Press the "Return" key to return to the Peripheral Setup menu to enter the Fuel Setup interface. This feature can be enabled only when an external Fuel level sensor is connected and the enable feature is on. Coefficient = total capacity of the Fuel tank (X) /height (mm) *100%

This coefficient shall be set according to the size of your Fuel tank to indicate how much of Fuel capacity corresponding to 1L of Fuel.

6. 6: Serial Device Setup

Press the "Return" key to return to the Peripheral Setup menu to enter Serial Device Setup interface. This setting requires connection to the related serial device. You can set related parameters according to the related serial device settings. In generally, default settings are used.

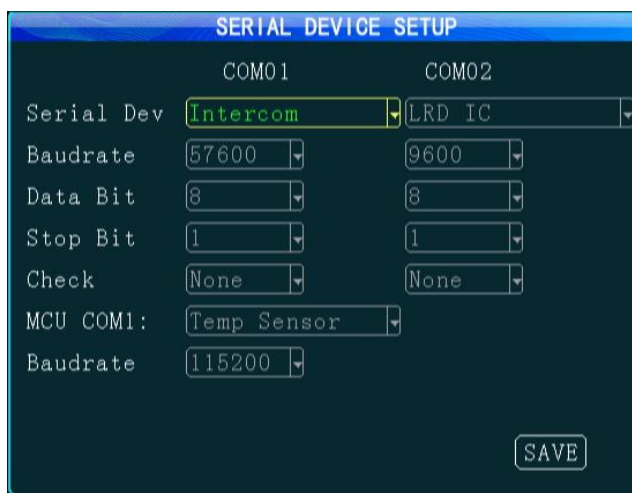

1. After an external RS232 device is connected, related sensor feature can be used only when serial port 1 or serial port 2 is set to related serial device name;
2. After setting, move your cursor to the "Save" key and press the "ENTER" key to save it.

7. Record Search:

Press the "Return" key to return to the Configuration menu to select the Record Search option.

You can play the video file in the search result.

The calendar with a green background indicates that there is a log that can be searched by simply selecting date, time, record type and related channel.

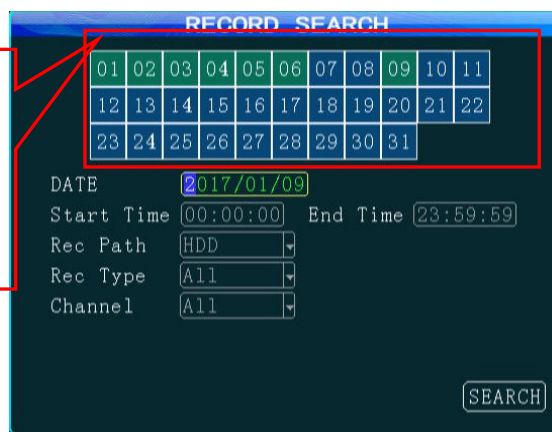

1. 3G and WiFi shall be disabled before export operation;

8. System Information:

In Quad View mode, you can either press the INFO key on your remote control or enter the setup menu to display the system information.

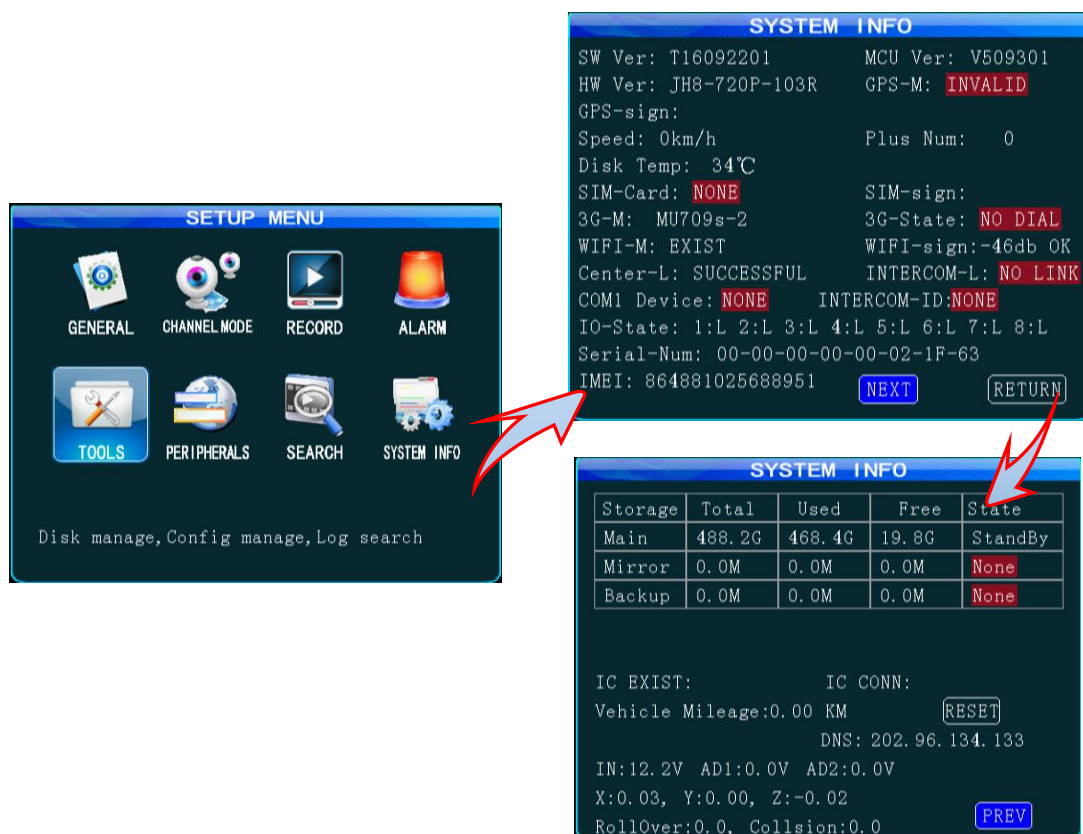

Appendix 1: Common Questions and Answers (QA) for MDVR

Q: What shall we do when a problem that could not be solve occurs to the product?

A: Record product model and software version number and submit detailed problem description to our technical support engineer for analysis. Detailed description will be very helpful to our analysis.

Q: What shall we do when the mobile device has no video output?

A: 1. Check the power status of the device. If only one blue indicator is lit up, it indicates that the device is still in standby mode and not powered on; at the same time, check if red or yellow cable of the main power is supplied normally; If not, the device cannot be started.

2. Check if the display is powered and if the display video is switched to AV status.

3. Check the connection status of the video output cable and display.

4. Check the lock status the mainframe lock; the device can be started only when the lock is

locked.

Q: What shall we do when the mainframe video input interface is different from the camera input interface?

A: a 4-pin interface is used for the vehicle device. BNC interface or air interface is used for the camera. If inconsistency is found, please use an adapter or connect it to a standard line defined as the line sequence for the vehicle device.

Q: What shall we do if recording is unavailable even when the device is powered on and HDD is installed?

A: 1. Check that the HDD is formatted after HDD is installed and HDD without formatting cannot be used. From the Main Menu-Management Tool-Formatting, format the newly-installed HDD.

2. Check if the record channel is off or if timing record is set. Recording is unavailable when it is not within the recording time frame.

3. Check if the HDD is properly contacted, and the HDD on the front panel is lit up.

Q: A record file is lost or no record file is found within a certain period of time?

A: 1. Analyze to define the period of time between the final video file is lost and the first video file is recovered.

2. Check if the device is power on within this period of time, for example, delay record not set during mid-way shutdown or unloading & loading.

Q: The vehicle PTZ cannot be controlled and cannot be rotated to up, down, right and left?

A: Check if the protocol and baud rate of the PTZ are set correctly, the address is consistent and if the channel video is selected to be maximized when controlling the PTZ. For example, when controlling the second channel, you shall maximize the image in the second channel to control the PTZ.

GPS related problems

Q: GPS module is present but no coordinate information is available?

A: 1. Check if the GPS module is present; if not, please check if the HDD is installed or properly contacted.

2. Check if GPS antenna is properly contacted and if the antenna is broken. The antenna is recommended to be placed in an area having strong signal. Note that some car glass shielding film may form a GPS signal.

3. If the test is conducted indoors and the GPS antenna set indoors is shielded, it is recommended to place the GPS antenna outdoors.

Q: GPS geographic position is not accurately displayed on the map?

A: if the GPS module is positioned, it indicates that the signal is valid. Government limitation, error tolerance or GPS signal interrupt may cause deviation; The satellite map may have some deviation by for the sake of safety. In general, this problem can be solved by using GPS correction.

3G/4G wireless related problems

Q: What shall be noted if 3G wireless module is used for dial up?

A: If built-in wireless module WCDMA or EVDO is selected, the module settings are different and also depend on the model used; thus, please check the consistency between the module used and SIM card. Do not use Telecom Card in WCDMA-enabled devices.

2. Check if the server IP or port is correctly set, if 3G/4G signal is intense enough for dial up, and if dial up via 3G/4G is successful.

3. Please check if the 3G/4G antenna is properly contacted when dial up fails. Weak signal may result in failure to dial up; in addition, check if the SIM card has sufficient traffic; if not, dial up will also fail.

Q: What shall we do when no video is reported via 3G/4G?

A: press the "INFO" key to enter the System Information page, where you can check if the SIM card is present, inspect signal intensity and dial-up status, and check if the antenna is properly

contacted. Then, check if the SIM card has traffic and replace it with a new one to re-check it. This is a most basic judgment criteria. If a signal is available, while dial up fails, check if the center number and port are set correctly. Then, check if the device number is unique.

Q: 3G/4G signal is intermittent and video is not smooth

A: So far, WCDMA and EVDO has good coverage (4G is desired to be improved). In case where signal is not covered in some mountainous areas or signal is weak due to local network restrictions in some suburban areas, the video may not be smooth or even cannot be viewed. In this case, it is largely affected by the local network; in addition, check if the frame rate for the sub stream is set too high. This may occur when the network condition is poor while the frame rate is high.

Q: Connection is impossible even when WiFi signal is up to -60db

A: If your WiFi is correctly set, connection is generally not a problem when signal intensity is up to -60db. If the device cannot be found within LAN, check if SSID and password are correctly set. Of course, the IP address shall be properly set; in addition, check the encryption type and authentication mode are set to requirements.

IVMS related problems

Q: The device is powered on while the IVMS client displays no vehicle information and video

A: Firstly, check the central registration server is powered on and online and then check if the device number is used, thereby causing conflict; secondly, check if the IP and port number are set correctly for the server center; Check if the device reports information to the central server via built-in 3G module or WiFi. If the built-in 3G is used, check if the right type is selected; for example, WCDMA and EVDO corresponds to related SIM cards. Check if the antenna is properly contacted, if data access point and center number are correctly set. If it still does not work, please collect information as much as possible and submit it to technical support for analysis to facilitate troubleshooting.

Q: the device is online but video image is not displayed?

A: Please set a lower sub-stream to transmit images. When the sub-stream is set too high, block or

slower transmission rate may result due to upload limit of the network; the video transmission may be seriously affected due to weak network signal or intermittence.

Q: the device normally reports information to the IVMS while video cannot be displayed after a period of time?

A: Firstly, check if the device information displays dial-up. If yes, the traffic for the SIM card may be used up. Please replace with a new one for test; secondly, check if the device number is tampered. If yes, your vehicle information shall be reported again to the server; thirdly, if card replacement cannot still solve this problem, check if the device 3G module is faulty.

Appendix 2: AL3000-HD Memory Space Reference

Correspondence of Picture Quality and Record Space

	Picture Quality	1	2	3	4	5	6	7	8
	Resolution								
Record space M/h	CIF	675	563	450	338	225	167	113	56
	HD1	900	788	675	563	450	338	225	169
	D1	900	788	675	563	450	338	225	169
	960H	900	788	675	563	450	338	225	169
	720P	1800	1350	900	675	450	338	225	169

The above table shows the record space required for one-way image per hour. This table is for reference only. The size of video file is related to illumination change and object motion of the current channel. Video file may be much smaller. To save space, you can disable audio or undesirable video channel.